

# Mitcorp INDUSTRIAL VIDEOSCOPE

■ CLEARNESS ■ SHARPNESS ■ BRIGHTNESS



X500 | MX 500  
X1000 PLUS | MX 1000



**Russell Fraser Sales** Pty Ltd

Unit 10 / 1-11 Burns Road, Heathcote NSW 2233 Australia

Ph: +61 2 9545 4433 Email: [rfs@rfsales.com.au](mailto:rfs@rfsales.com.au) Website: [rfsales.com.au](http://rfsales.com.au)







# SUPER IMAGE QUALITY

Our outstanding image processing technology implementation to sharpen the edges and optimize the image quality for best inspection result.

## DIVERSE APPLICATIONS

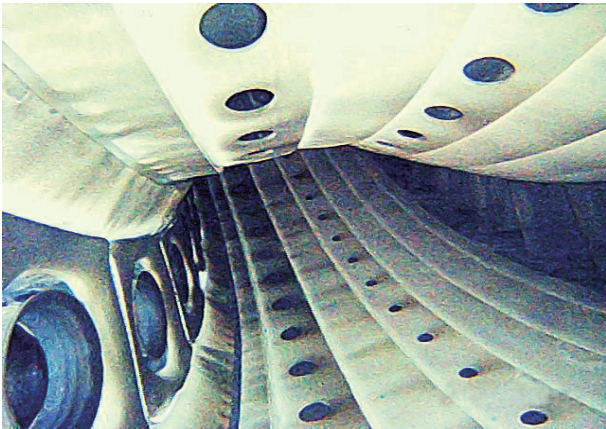

COMBUSTION CHAMBER



COMBUSTION CHAMBER

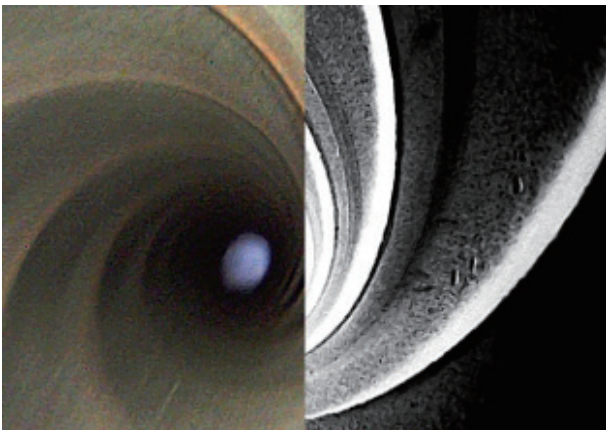

INNER SPIRAL PIPE

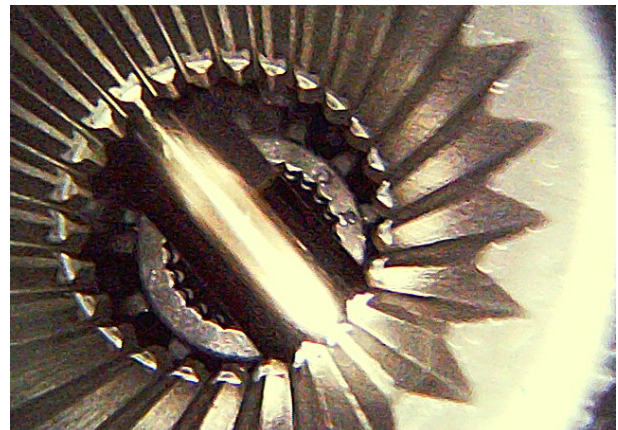

GEAR BOX



AIR COMPRESSOR

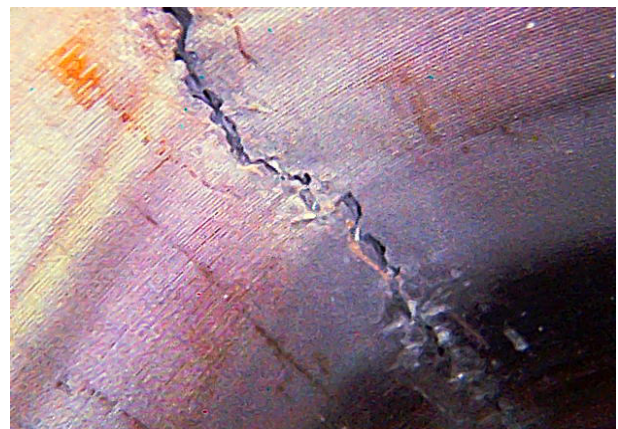

CRACKING



# MX1000



Actual Size : 235x150mm







(1:1)

Actual Size : 80x190mm (1:1)



# Product Outlook / Operations

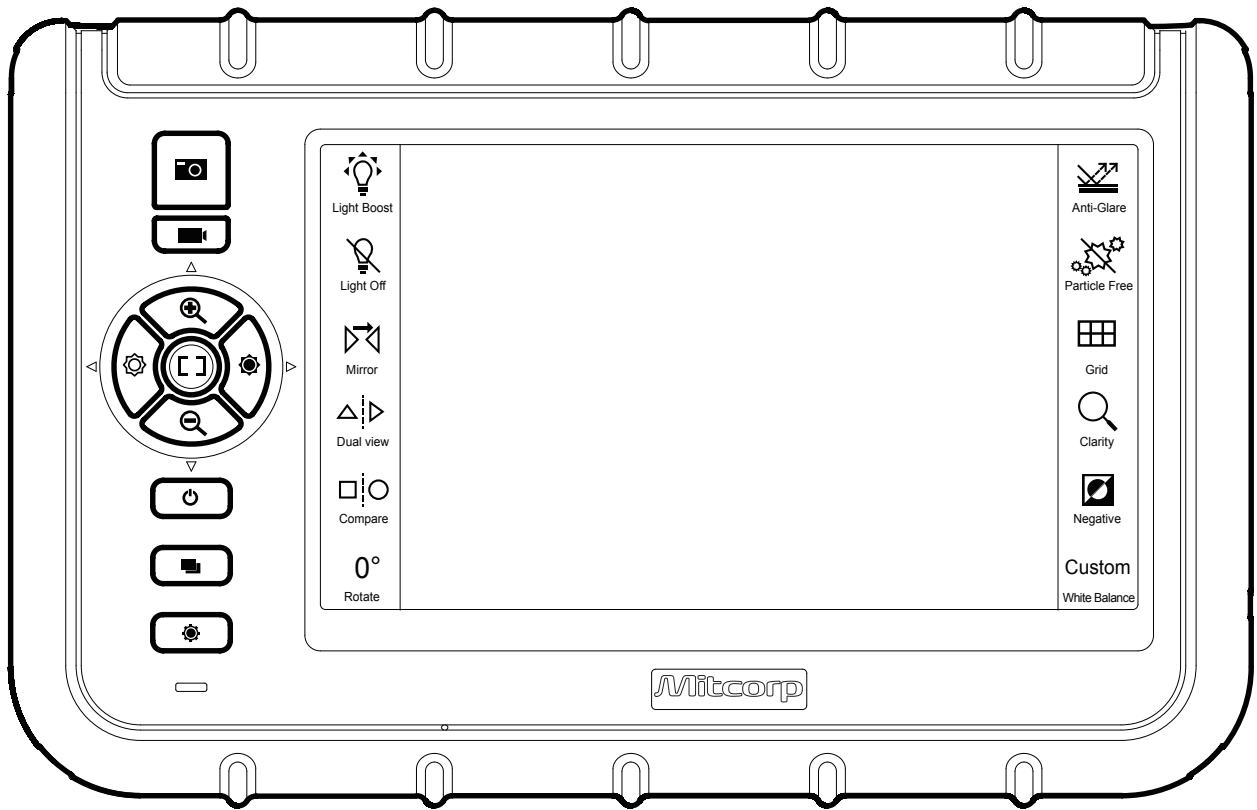

 **Light Boost** Light enhanced Mode



 **Dual view** (designated mirror is needed) The screen will display both front view and side view (when using dual view mirror).

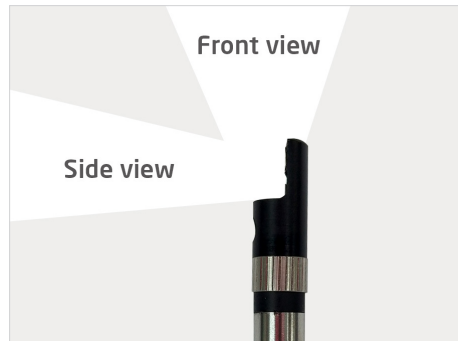
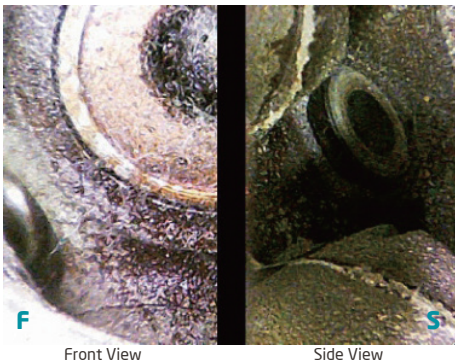





Compare

## Compare

Compare stored image with live view

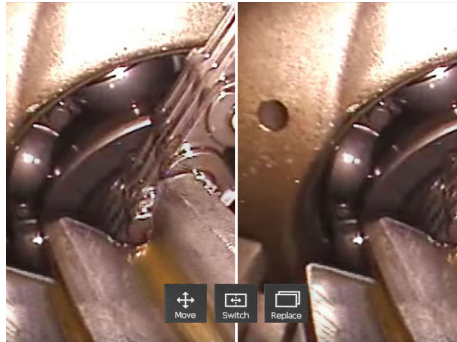

Live View

Stored Picture

## ADD NOTE

To put comparison information or comments on the captured image

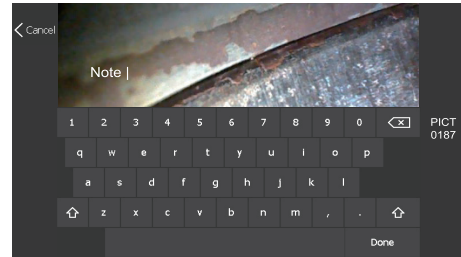

Particle Free

## Particle Free

Dust elimination (when using side view mirror)



w/o Particle free



Particle free



Negative

## Negative

Image contrast

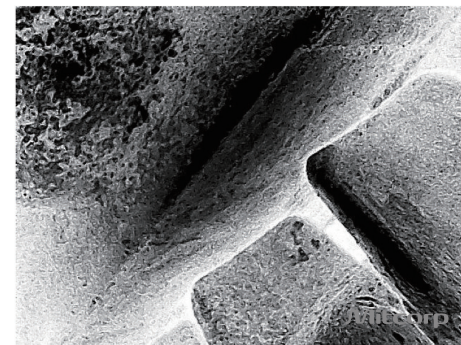

Custom  
White Balance

## Auto White Balance

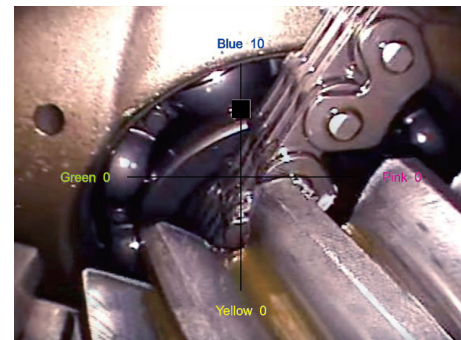
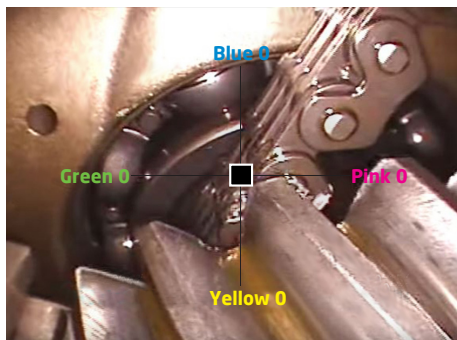



**MX1000**



Features	Description
Display	7" LCD (800 * 480)
Snapshot	400 * 400, .jpeg
Recording	400 * 400, .avi
Dimensions	240 * 154 * 47 mm
System Weight	1.3kg (2.86 lb)
Dust & Water proof	IP57
Drop resistance	1m
Power Supply	Rechargeable Li battery, approx. 3.5 hours charging/ operating AC power: 100-240V, 5V, 3A
Working temperature	0°C~45°C (with battery); 0°C~40°C (with AC power adaptor)
Storage temperature	0~60°C
Relative humidity	Max 95%, non condensing
Storage	SD card, up to 32G
AV output	NTSC / PAL
Audio input	Built-in microphone
Brightness Adjust	8 levels (6+2 Boost levels)

**MX500**



Features	Description
Display	5" LCD (640 * 480)
Snapshot	400 * 400, .jpeg
Recording	400 * 400, .avi
Dimensions	160 * 120 * 55 mm
Weight	745g (4.64 lb)
Waterproof	IP54
Drop resistance	1m
Battery	Rechargeable Li battery, approx. 3.5 hours charging/ operating AC power: 100-240V, 5V, 3A
Working temperature	0°C~45°C (with battery); 0°C~40°C (with AC power adaptor)
Storage temperature	0°C~60°C
Relative humidity	Max 95%, non condensing
Storage	SD card, up to 32G
Video output	NTSC / PAL
Audio input	Built-in microphone
LED indicator	Green LED: Power on ; Red LED: Charging system

**3.9mm Insert Tube Options**

**360 Articulations**



Features	Description
Probe Head Diameter	3.9mm
Probe Head Length	13mm
Probe Length	1.5m, 3m
LED	Front / Side
Probe Head Material	Stainless Steel
Articulations angle	Full ways 150°
Depth of Field (DOF)	10mm~60mm
Field of View (FOV)	90°
Working Temperature	-10°C to 60°C
Storage Temperature	-10°C to 60°C
Button	Snap / Recording, Brightness+, Brightness-
Articulation Shaft Lock	Left-open, right-lock
Resolution	400*400

\* The maximum articulation may degrade over time.

**Two ways Articulation**



Features	Description
Probe Head Diameter	3.9mm
Probe Head Length	13mm
Probe Length	1.5m, 3m
LED	Front / Side
Probe Head Material	Stainless steel
Probe material	Outer braided stainless steel
Articulations angle	Right-left 180°
DOF	10mm~100mm
FOV	90°
Working Temperature	-10°C to 60°C
Storage Temperature	-10°C to 60°C
Resolution	400*400

\* The maximum articulation may degrade over time.

**Cast probe**



Features	Description	
	Front View Probe	Side View Probe
Probe Head Diameter	3.9mm	3.9mm
Probe Head Length	5.6mm	7.6mm
Probe Head Material	Stainless steel	Stainless steel
Probe Diameter	3.9mm	3.9mm
Probe Length	1m	1m
Probe Material	Spring, stainless steel	Spring, stainless steel
LED	Front	Side
DOF	5mm-60mm	5mm-60mm
FOV	90°	90°
Working temperature	-10°C to 60°C	-10°C to 60°C
Storage temperature	-10°C to 60°C	-10°C to 60°C
Resolution	400*400	400*400
Button	Snapshot, Brightness+, Brightness-	Snapshot, Brightness+, Brightness-



Features	Description
Probe Head Diameter	3.9mm
Probe Head Length	12mm
Probe Length	1m
Probe Head Material	Stainless steel
Probe material	Steel, semirigid
LED	Front / Side
DOF	10mm~60mm
FOV	90°
Working Temperature	-10°C to 60°C
Storage Temperature	-10°C to 60°C
Resolution Pixels	400*400
Button	Snapshot, Brightness+, Brightness-



## X1000 PLUS



## X500



Features	Description
Display	7" LCD (800 * 480)
Snapshot	640 * 480, .jpeg
Recording	640 * 480, .avi
Dimensions	240 * 154 * 47 mm
System weight	1.3kg (2.86 lb)
Dust & Water proof	IP57
Drop resistance	1m
Power supply	Rechargeable Li battery, approx. 3.5 hours charging/ operating AC power: 100-240V, 5V, 3A
Working temperature	0°C~45°C (with battery); 0°C~40°C (with AC power adaptor)
Storage temperature	0°C~60°C
Relative humidity	Max 95%, non condensing
USB	Mass storage mode
Storage	SD card, up to 32G
AV output	NTSC / PAL
Audio input	Built-in microphone
Brightness Adjust	8 levels (5+3 Boost levels)

Features	Description
Display	5" LCD (640 * 480)
Snapshot	640 * 480, .jpeg
Recording	640 * 480, .avi
Dimensions	160 * 120 * 55 mm
Weight	745g (1.64 lb)
Waterproof	IP54
Drop resistance	1m
Battery	Rechargeable Li battery, approx. 3.5 hours charging/ operating AC power: 100-240V, 5V, 3A
Working temperature	0°C~45°C (with battery); 0°C~40°C (with AC power adaptor)
Storage temperature	0°C~60°C
Relative humidity	Max 95%, non condensing
Storage	SD card, up to 32G
Video output	NTSC / PAL
Audio input	Built-in microphone
LED indicator	Green LED: Power on ; Red LED: Charging system

## Insert Tube Options

### Two ways Articulation



4.5mm Front view

Features	Description	Features	Description
Probe head diameter	4.5mm	Button	Snapshot, Brightness+, Brightness-
Probe head length	13mm	Working temperature	-10°C - 60°C
Probe length	1.5m, 3m	Storage temperature	-10°C - 60°C
Articulations	right-left 180°(*)	Resolution	640x480
Probe head material	Stainless steel		
Probe material	Outer braided stainless steel		
LED	Front		
FOV	90°		
DOF	10mm~100mm		

\* The maximum articulation angle may degrade over time.

### Cast



5.4mm Front view

Features	Description	Features	Description
Probe head diameter	5.4mm	DOF	10mm~100mm
Probe head length	7.0mm	Working temperature	-10°C - 60°C
Probe diameter	4.5m	Storage temperature	-10°C - 60°C
Probe length	1m	Resolution	640x480
Articulations	0°	Button	Snapshot, Brightness+, Brightness-
Probe head material	Stainless steel		
Probe material	Stainless steel spring		
LED	Front		
FOV	90°		

### Macro



5.5mm Front view

Features	Description	Features	Description
Probe Head Diameter	5.5mm	Storage Temperature	-10°C to 60°C
Probe Head Length	20mm	Resolution	640x480
Probe Length	2m, 3m		
LED	Front / Side		
Probe Head Material	Stainless steel		
Probe material	Soft metal		
DOF	7mm~15mm		
FOV	60°		
Working Temperature	-10°C to 60°C		



6.0mm  
360 Articulation



## Intuitive mechanical articulation design

- Lightweight
- Reliable and durable
- Energy saving

Features	Description
Probe head diameter	6.0mm (w/o lock ring)
Probe head length	24mm
Probe length	2m / 3m / 5m / 7m
Weight	2m-720g ; 3m-790g ; 5m-930g ; 7m 1070g
Articulation angle	2m, 3m full ways $\geq 120^\circ$ ; 5m, 7m full ways $\geq 80^\circ$ (*)
Probe head material	Stainless steel
Probe material	Outer braide stainless steel
Light source	Front / Side
FOV	90°
DOF	10mm ~ 100mm
Relative humidity	Snap / Recording, brightness+, brightness-
Button	Left-open, right-lock
Shaftlock	-10°C ~ 60°C
Working temp	-10°C ~ 60°C
Storage temp	640 x 480

\* The maximum articulation angle may degrade over time.

**Brighter**  
Enhance 300% illumination than ever

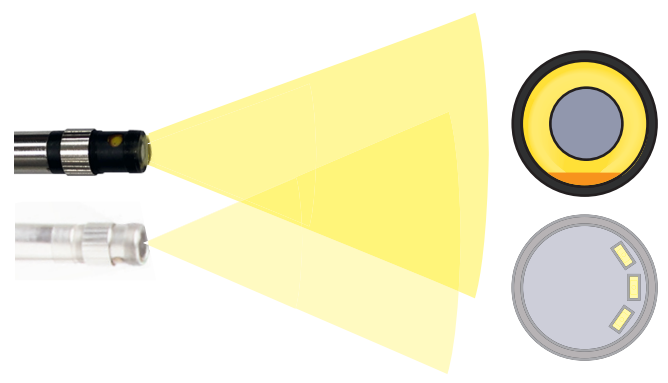

**Wider and Further**  
11 levels brightness adjustment

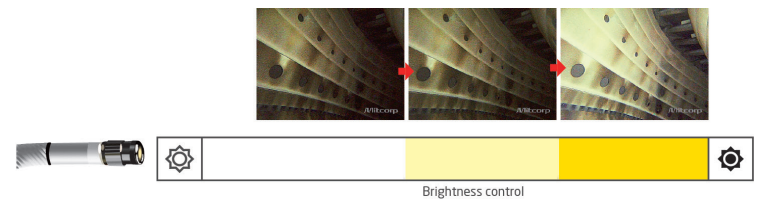

**Close up**  
90 degree Field of View  
10mm Depth of Focus

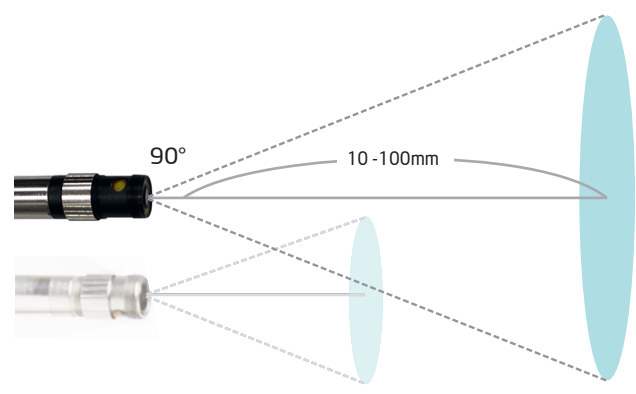



10 mm  
For Heat Exchanger

# PRM100



Features	Description
Probe head diameter	10mm
Probe head length	10mm
Probe length	15m / 25m
Probe head material	Stainless Steel
Probe material	Stainless Steel Spring/FRP
LED	Front/Side
Button (on meter)	Power, m/ft switch, LED backlight
Water proof	Under water 1m for 30 minutes
DOF	10mm~100mm
FOV	87°
Resolution	640 x 480
Working temperature	0°C ~ 60°C
Storage temperature	0°C ~ 60°C

## ACCESSORIES

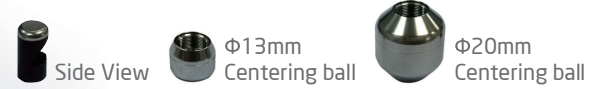

- 10mm diameter probe, perfect for heat exchanger inspection
- 15m / 25m pipe provides inspection flexibilities
- Work with X1000 PLUS videoscope system



INNER SPIRAL PIPE (FRONT VIEW)

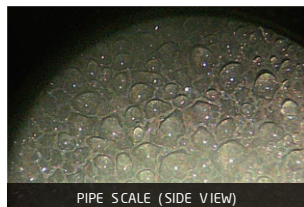

PIPE SCALE (SIDE VIEW)

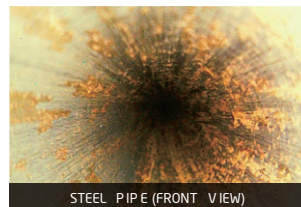

STEEL PIPE (FRONT VIEW)



WELD JUNCTION (SIDE VIEW)

# ACCESSORIES



3.9mm  
dual view



3.9mm  
side view



3.9mm  
pin



6.0mm  
dual view



6.0mm  
side view



6.0mm  
pin



Holding tube



Neck strap



Remote control



Power adaptor



USB charging cable  
(For power bank)



Sun visor



Hand strap



Trolley Case

\*Also include : USB cable, AV cable, clean set, SD card, user manual, installation CD

# Mitcorp



FB: Mitcorpglobal



Youtube: Mitcorpglobal



✉ e-mail: [sal@mitcorp.com.tw](mailto:sal@mitcorp.com.tw) website: [www.mitcorp.com.tw](http://www.mitcorp.com.tw)

2F., No.75, Wenhua 1st Rd., Guishan, Taoyuan 333, Taiwan  
T+886-3-328-7177 F+886-3-328-7176

