

G60 Handheld Thermography Camera



The thermographic handheld camera is based on the thermal technology, specially designed for the needs of temperature measuring applications. People can quickly troubleshoot faults on-site.

Key Features

- Thermal resolution: 640 x 512 (327 680 pixels)
- NETD : < 35 mK (@ 25 °C,F#=1.0)
- Temperature measurement range : -20 °C to 650 °C (-4 °F to 1202 °F)
- Accuracy: Max ($\pm 2^{\circ}\text{C}/3.6^{\circ}\text{F}$, $\pm 2\%$)
- Measurement Presets: Center spot, Hot spot, Cold spot, User Preset Point/Line/Area
- Auto/Manual/Laser focus
- 50 Hz image frequency
- 4.3" LCD touch screen display
- 8MP Optical camera
- Up to 4 hours continuous running

Specification

Thermal Module	
Image Sensor	Vanadium Oxide Uncooled Focal Plane Arrays
IR Resolution	640 x 512 (327 680 pixels)
Pixel Pitch	17 μ m
Spectral Range	8 - 14 μ m
NETD	< 35 mK (@25°C), F#=1.0
Focal Length	25 mm
FOV (Field of View)	25° x 19°
Image Frequency	50 Hz
Focus	Continuous Autofocus/Autofocus/Manual Focus/Laser Assisted Focus
IFOV (Spatial Resolution)	0.68 mrad
Aperture	F1.1
Minimum Focus Distance	0.3 m (0.98 ft)
Optical Module	
Picture Resolution	Configurable: 2 MP, 5 MP, 8 MP
Video Resolution	640 x 480
Focus	Fixed
FOV	25° x 19°
Image Display	
Display	800 x 480 Resolution, 4.3" LCD Touch Screen
Color Palettes	White Hot, Black Hot, Rainbow, Ironbow, Red Hot, Fusion, Rain
Digital Zoom	1x, 2x, 4x, 8x
Image Modes	Thermal/Optical/Fusion/PIP
PIP	Thermal Picture in Optical Picture
Fusion	Thermal Picture and Optical Picture Combined
Measurement and Analysis	
Object Temperature Range	-20 °C to 650 °C (-4 °F to 1202 °F)
Accuracy	Max ($\pm 2^{\circ}\text{C}/3.6^{\circ}\text{F}$, $\pm 2\%$)
Measurement Presets	Center Spot, Hot Spot, Cold Spot, Off
Point	10 User Presets
Line	1 User Preset
Area	3 User Presets
High Temperature Alarm	Audible Warning
Color Alarm (Isotherm)	Above/Below/Interval/Insulation
Storage	
Storage Media	Removable Micro SD Card (64 GB)
Image Storage Capacity	60 000 Images
Image File Format	BMP with Measurement Data Included
Video Storage Capacity	54 Hours

Video File Format	MP4
Functions	
Laser Pointer	Yes
Laser Type	Class II
Wi-Fi	802.11 b/g/n (2.4 GHz)
Bluetooth	Bluetooth 4.2
Level/Span	Auto/Manual
Text Comment	Max 200 Characters
Voice Comment	Max 60 Seconds
UVC Cast Screen	Yes
Power System	
Power Supply	12 V DC/1.5A, 5V DC/2A (Charging via USB)
Power Consumption	5 W
Battery Type	Dismountable and Rechargeable Li-ion Battery
Battery Operating Time	4 Hours Continuous Running
General	
Menu Language	17 Languages English, Russian, Hungarian, German, Italian, Czech, Slovak, French, Polish, Portuguese, Spanish, Romanian, Danish, Turkish, Korean, Traditional Chinese, Japanese
Working Temperature Range	-20 °C to 50 °C (-4 °F to 122 °F)
Storage Temperature Range	-20 °C to 60 °C (-4 °F to 140 °F)
Protection level	IP54
Drop Test Height	2 m (6.56 ft)
Interface	USB Type-C
Weight	Approx. 1000 g (2.20 lb)
Dimension	284.7 mm × 118.3 mm × 127.1 mm (11.21 " × 4.66 " × 5.00 ")
Tripod Mounting	UNC ¼"-20

Packing List

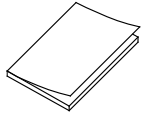

Quick Start Guide (x1)



Type-C Cable (x1)

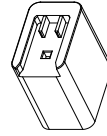

Power Adapter (x1)

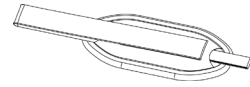

Hand Strap (x1)

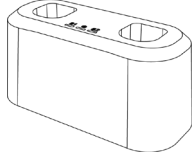

Charging Base (x1)

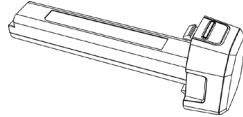

Battery (x2)

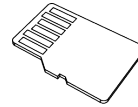

Micro SD Card (x1)



CVBS Cable (x1)

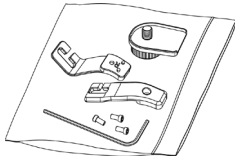

Tools Package (x1)

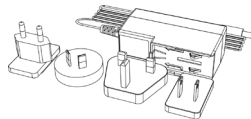

Charger (x1)

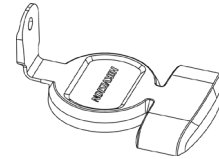

Lens Cover (x1)

Optional



Teleconverter 0.5X

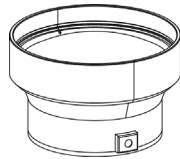

Teleconverter 2X

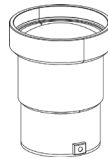

Teleconverter 3.3X

Available model

HM-TP76-25SVF/W-G60

Dimension

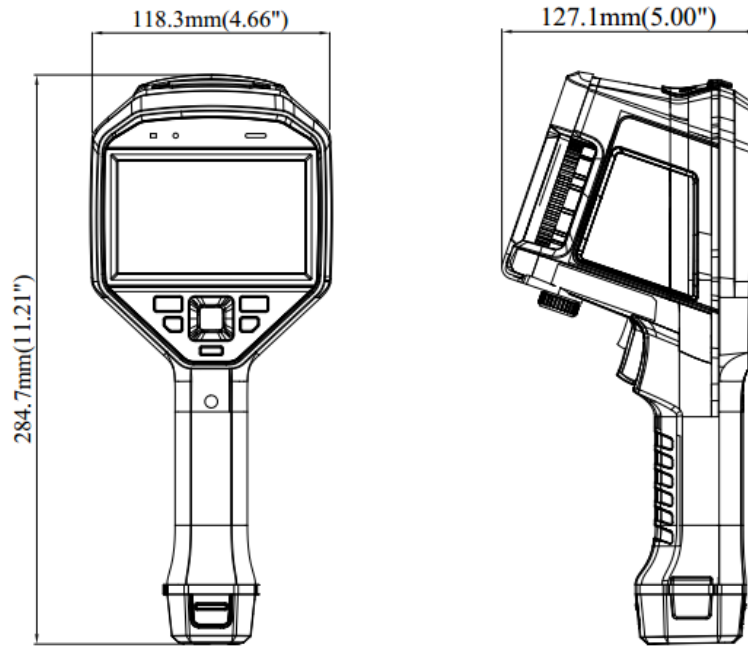

Russell Fraser Sales Pty Ltd

Unit 10 / 1-11 Burns Road, Heathcote NSW 2233 Australia

Ph: +61 2 9545 4433 Email: rfs@rfsales.com.au Website: rfsales.com.au